

# Investigation Report of Oscillation Circuit

\*at Vdd=3.3V/25°C

IC		<b>Microchip Technology Inc.</b>	
		<b>PIC16F1828</b>	
CRYSTAL		<b>CM200C</b>	
Nominal Frequency	kHz	32.768	
Laod Capacitance	pF	7	
Cg,Cd	pF	8	8
Negative Resistance (-R)	ohm	360k	
Drive Level	μW	0.1	

\* Our Recommendable Negative Resistance Value : over 200k ohm

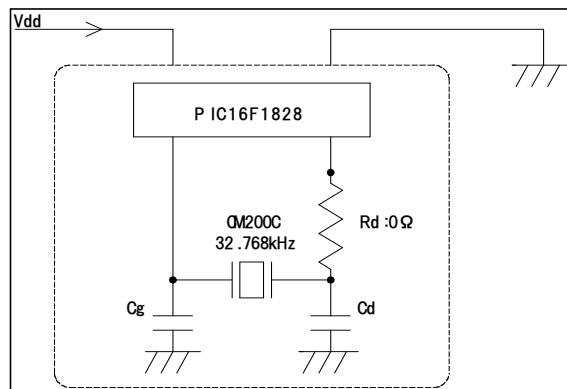

\*These recommendations are based on actual evaluation results and intended to support users in picking the right components. As the actual board layout and choice of external components influences the best suitable crystal load capacitance, we does not assume evaluation. Please refer to IC maker's manual for designing.

## CM200C

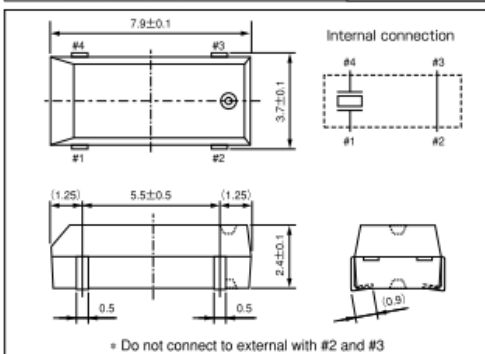

**TUNING FORK CRYSTAL UNIT**

- Molding a heat resistance cylinder with resin.
- Most appropriate for clock source for portable equipment with low power consumption.

<b>Standard Specification</b>		
Nominal Frequency	kHz	32.768
Frequency Tolerance	ppm	+/- 20 (at 25°C)
Operatating Temperature Rang	°C	-40 to 85
Storage Temperature Range	°C	-55 to 125
Motional Resistance	Ω	50k
Level of drive	uW	1 Max.
Insulation Resistance	MΩ	500 Min. (at DC100+/-15V)