

Investigation Report of Oscillation Circuit

*at Vdd=3.3V/25°C

IC		Microchip Technology Inc.	
		PIC16F1828	
CRYSTAL		CMR200T	
Nominal Frequency	kHz	32.768	
Laod Capacitance	pF	7	
Cg,Cd	pF	8	8
Negative Resistance (-R)	ohm	370k	
Drive Level	μW	0.1	

* Our Recommendable Negative Resistance Value : over 200k ohm

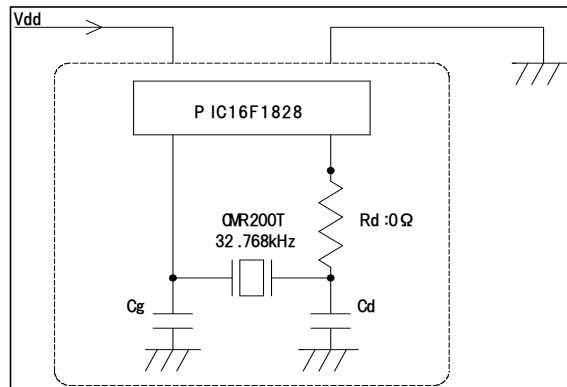

*These recommendations are based on actual evaluation results and intended to support users in picking the right components. As the actual board layout and choice of external components influences the best suitable crystal load capacitance, we does not assume evaluation. Please refer to IC maker's manual for designing.

CMR200T

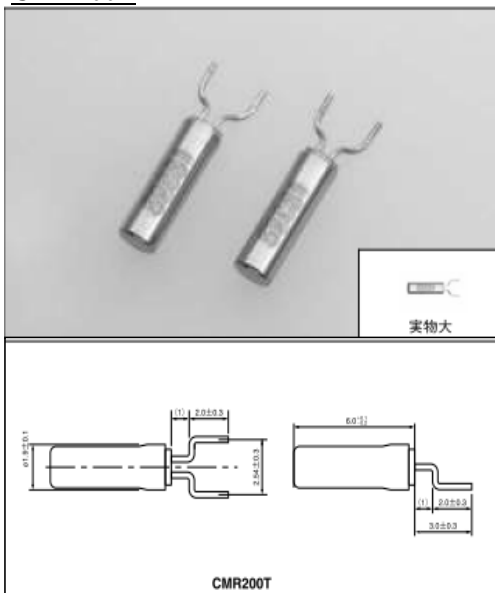

TUNING FORK CRYSTAL UNIT		
<ul style="list-style-type: none"> ■ Lead formed SMD type with embossed tape. ■ Most appropriate for clock source for portable and other various equipment with low power consumption. 		
Standard Specification		
Nominal Frequency	kHz	32.768
Frequency Tolerance	ppm	+/- 20 (at 25°C)
Operatating Temperature Rang	°C	-40 to 85
Storage Temperature Range	°C	-55 to 125
Motional Resistance	Ω	50k
Level of drive	uW	1 Max.
Insulation Resistance	MΩ	500 Min. (at DC100+/-15V)