

Investigation Report of Oscillation Circuit

*at Vdd=3.3V/25°C

I C		Microchip Technology Inc.	
		PIC16F1828	
CRYSTAL		CM130	
Nominal Frequency	kHz	32.768	
Laod Capacitance	pF	7	
Cg,Cd	pF	8	8
Negative Resistance (-R)	ohm	360k	
Drive Level	μW	0.1	

* Our Recommendable Negative Resistance Value : over 200k ohm

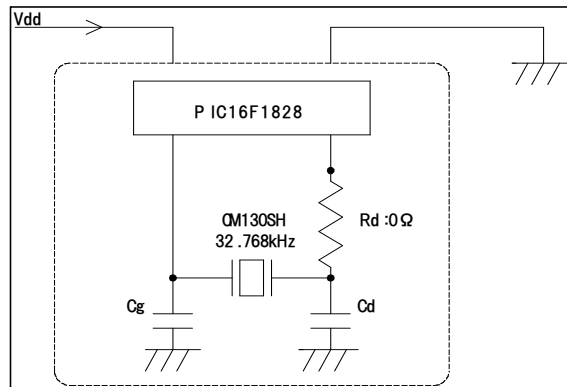

*These recommendations are based on actual evaluation results and intended to support users in picking the right components.

As the actual board layout and choice of external components influences the best suitable crystal load capacitance, we does not assume evaluation.

Please refer to IC maker's manual for designing.

CM130

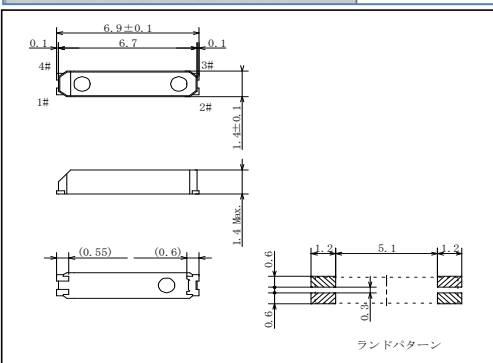
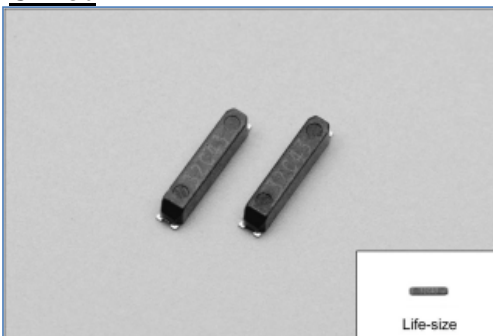

TUNING FORK CRYSTAL UNIT

- Most appropriate for high-density circuit board by the small surface mount type.
- Embedded with heat resistant cylinder type crystal bring highly stable characteristics.
- Suitable for small mobile telecommunications devices.

Standard Specification

Nominal Frequency	kHz	32.768
Frequency Tolerance	ppm	+/- 20 (at 25°C)
Operatating Temperature Rang	°C	-40 to 85
Storage Temperature Range	°C	-55 to 125
Motional Resistance	Ω	65k
Level of drive	uW	1 Max.
Insulation Resistance	MΩ	500 Min. (at DC100+/-15V)